



# HISTORIC TECHNICAL PASSPORT (HTP)

## 2020 DETAILED GUIDELINES

A WORLD IN MOTION

**ALL FIA HISTORIC CONTENT AVAILABLE ON**  
[WWW.FIA.COM/HISTORIC](http://WWW.FIA.COM/HISTORIC)

The texts and documents in the present brochure are for information only. The only regulations that are considered official are those published in the FIA Yearbook of Automobile Sport, in the periodical FIA Bulletins and on the FIA website.

\*\*\*\*\*

**FIA HISTORIC DATABASE ON** [WWW.HISTORICDB.FIA.COM](http://WWW.HISTORICDB.FIA.COM)

FEDERATION  
INTERNATIONALE  
DE L'AUTOMOBILE

FIA.COM



*PURPOSE OF THE DOCUMENT*

*THE APPLICATION PROCEDURE*

*GENERAL FEATURES*

*HOW TO FILL THE FORM*

*PICTURES & FORMAT*

*ROPS CERTIFICATES*

*COMMON MISTAKES*



The Historic Technical Passport (HTP) serves two purposes, firstly for the use of technical and eligibility officials at competitions and secondly for the use of competition organisers in both classification and class structure for their competitions.

As stated on the first page of the document:

- The HTP is not a certificate of authenticity, nor does it in anyway verify the history of the car or its constituent parts.
- The FIA merely certifies that the required information gathered and confirmed by the ASN at the date of the inspection, is sufficient for the car to be eligible to compete in FIA-sanctioned events for historic vehicles.
- Neither the FIA nor the ASN certifies or takes responsibility for the accuracy of the items shown below as «represented» as those were provided by the applicant (as detailed in Page 24), on behalf of the owner, based upon his best available knowledge and are not verifiable by the ASN and/or the FIA.

As detailed into Appendix K under Article 4.3, there are procedures in case of non-conformity:

- The red dot procedure if the car is presented with a minor irregularity and which may require an update of the papers.
  - *Ex: Wrong technical description or mistake in the form, technical irregularity that does not affect performance.*
- The black dot procedure if the car is presented with a safety irregularity.
  - *In that case, the car cannot take part in the Competition.*
- For non-conformities that have an affect on the performance of the car, those shall be reported to the Stewards.

For the full regulatory texts, these are available in Appendix K.



*PURPOSE OF THE DOCUMENT*

*THE APPLICATION PROCEDURE*

*GENERAL FEATURES*

*HOW TO FILL THE FORM*

*PICTURES & FORMAT*

*ROPS CERTIFICATES*

*COMMON MISTAKES*





To apply for an HTP, three steps need to be carried out:

1. Define the requested technical specification of the car, that needs to have existed in period.
2. Refer to the applicable regulations:
  - Appendix K, the Homologation form and the corresponding Appendix J for a HOMOLOGATED CAR;
  - Appendix K, the period Appendix J and possibly Championship regulations for a NON-HOMOLOGATED CAR.
3. Compile the HTP application in accordance with the above.
  - If you wish to use additional specification to the one presented originally, for a different wing assembly or engine as an example, that specification will have to be added through a Variant to the base HTP. It can be submitted from the start of the procedure along with the other forms and for as many specifications as you wish to use.

Once the above is settled and the form is filled-in, it will be reviewed by your ASN and then submitted to the FIA for final consideration by the FIA Vehicle Compliance Sub-Commission. The purpose of this worldwide spread panel is to consider each application and its compliance with the relevant regulations and period specification.

Should there be administrative mistakes, non-compliance and/or need for clarification, comments will be returned to the ASN in charge of the application for further consideration. If everything is in order, the application will simply be validated and a FIA Database Number issued.



*PURPOSE OF THE DOCUMENT*

*THE APPLICATION PROCEDURE*

*GENERAL FEATURES*

*HOW TO FILL THE FORM*

*PICTURES & FORMAT*

*ROPS CERTIFICATES*

*COMMON MISTAKES*



The 2020 HTP Template has been developed following the FIA observations and feedback from both the VCSC but also according to the feedback of ASNs involved in the process. The new form is a more efficient document which should help ASNs and their Secretariat as well as the FIA in ensuring higher consistency and standards.

### Main changes

- *PDF Form*
- *Automated FORM NUMBER and ISSUING ASN fields built-in throughout the document;*
- *Automated MANDATORY FIELDS (\*) with built-in verification tool on each page and for each section;*
- *All pictures to 16:9 (1280x720px) format;*
- *New picture requirement for specific cases (listed hereafter);*
- *New ASN issuing procedure built into the form.*

### What stays the same

- *The document and sections are the same, still 27 pages, plus the Application form;*

There are 3 major types of fields to fill the form.

### 1<sup>st</sup> type: Simple Drop-Down Menus

Click on the menu and then chose the applicable description.

Mandatory fields \*

**HISTORIC TECHNICAL PASSPORT VALID IN RACING & HILL-CLIMB** \*

Select the appropriate entry, up to 3 disciplines may be entered.

Mandatory fields \*

**HISTORIC TECHNICAL PASSPORT VALID IN RACING & HILL-CLIMB** \*

**HISTORIC TECHNICAL PASSPORT VALID IN : - -**

**HISTORIC TECHNICAL PASSPORT VALID IN RACING**

**HISTORIC TECHNICAL PASSPORT VALID IN RACING & HILL-CLIMB & RALLY**

**HISTORIC TECHNICAL PASSPORT VALID IN RACING & HILL-CLIMB** \*

**HISTORIC TECHNICAL PASSPORT VALID IN RALLY** \*

**HISTORIC TECHNICAL PASSPORT VALID IN HILL-CLIMB** \*

PERIOD F - 01/01/1962 to 31/12/1965 Valid to 31.12.2020 FIA CLASS : GTS12 \*

### 2<sup>nd</sup> type: Drop-Down Menus opening a further field.

Depending on the answer which may be "YES" or "NO", different possibilities may arise.

1. "YES" will mostly lead you to continue to the next drop-down menu and so on;
2. "NO" will require you to fill-in a further text field aimed at clarifying your answer.

2.2 IGNITION	
[a]	Is the system as per the period specifications? <span>YES</span> *
[b]	<i>Not applicable</i>

Choose "YES" or "NO"

2.2 IGNITION	
[a]	Is the system as per the period specifications? <span>YES</span>
[b]	<i>Not applicable</i>

Option 1 – "YES"  
No clarification required  
=> Onto the next field.

2.2 IGNITION	
[a]	Is the system as per the period specifications? <span>NO</span>
[b]	Please clarify

Option 2 – "NO"  
Clarification is MANDATORY

### 3<sup>rd</sup> type: Images

In order to insert an image, click within the picture box, either select the image through a pop-up window which will invite you to browse through your file or clear the field if you need to insert another one.

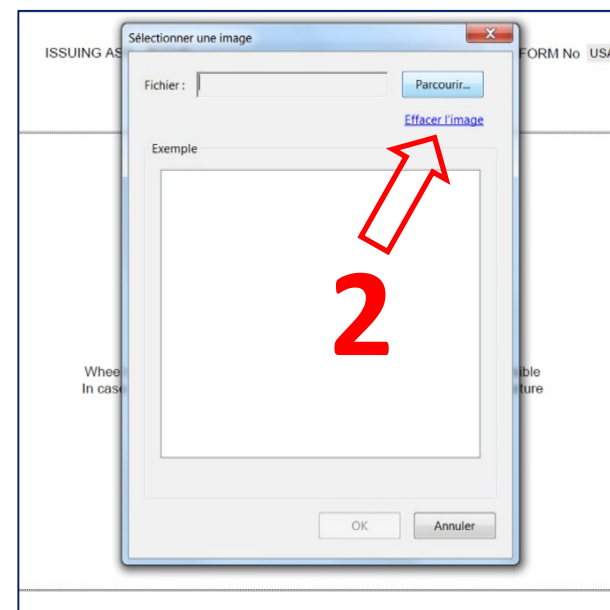

Once you've chosen the picture, it will automatically adjust to the size of the box.

All pictures are MANDATORY



### *A few tips and tricks about the form.*

For questions such as "Is the xxxxx as per the period specification?", two answers are possible:

- If that element is as per the original model → Chose YES and move to the next field;
- If you have modified that element compared to the original model → Chose NO and explain the modification in the following Clarification field, which is mandatory.

For questions such as "Are sensors fitted?", two answers are possible:

- The original car has not been equipped with additional sensors → Chose NO and leave the next field blank;
- The original car « stock » has been equipped with additional sensors → Chose YES and detail which ones on the next field.

Note that the following instruments do not need to be filled in: Engine RPM, engine oil pressure & temperature, engine water temperature and fuel pressure.

### **!/ ALL FIELDS MUST BE FILLED IN!**

For cases where the requested information does not exist, state "N/A". This enables administrative services to ensure that there is no oversight.

In terms of material, as all metals are alloys, you must always specify their base material (steel, aluminium, magnesium, etc.).



*PURPOSE OF THE DOCUMENT*

*THE APPLICATION PROCEDURE*

*GENERAL FEATURES*

*HOW TO FILL THE FORM*

*PICTURES & FORMAT*

*ROPS CERTIFICATES*

*COMMON MISTAKES*





### HISTORIC TECHNICAL PASSPORT VALID IN RACING & HILL-CLIMB \*

*This Technical Passport is not a certificate of authenticity, nor does it in anyway verify the history of the car or its constituent parts. The FIA merely certifies that the required information gathered and confirmed by the ASN at the date of the inspection, is sufficient for the car to be eligible to compete in FIA-sanctioned events for historic vehicles.*

*Neither the FIA nor the ASN certifies or takes responsibility for the accuracy of the items shown below as «represented» as those were provided by the Applicant (as detailed in Page 24), on behalf of the owner, based upon his best available knowledge and are not verifiable by the ASN and/or the FIA.*

**ISSUING ASN :** AUTOMOBILE COMPETITION COMMITTEE FOR THE UNITED STATES FIA INC. \*

**FORM NUMBER :** USA-XXX1 \* **CATEGORY :** COMPETITION GT CAR \*

**PERIOD F** \* - 01/01/1962 \* to 31/12/1965 \* **Valid to** 31.12.2020 **FIA CLASS :** GTS12 \*

**“VALID IN” – Drop-down menu:** Disciplines in which the car will be entered.

**!/ Risk of error:** Selecting disciplines for which the car is not eligible (e.g. Rally despite having no bumpers on the car).

**Issuing ASN:** To be completed by the ASN.

**Form number:** To be completed by the ASN. The ASN number consists of the letter of the country and a four-digit number starting from 5000.

**Category – Drop-down menu:** Category of the car, in accordance with Appendix I to Appendix K.

**!/ Risk of error:** Not knowing the FIA category and being too literal (e.g. a Ford Sierra RS Cosworth Group A taking part in Rally is not a “Two-Seat Racing Car” but a “Competition Touring Car”).

**Period – Drop-down menu:** Period of the car’s specification in accordance with Article 3.2 of Appendix K.

**!/ Risk of error:** Focusing on the letter and forgetting to type the years and vice-versa.

**Valid to ...:** To be completed by the ASN. The year should be a 4 figure number.

**FIA Class:** According to Appendix I to Appendix K.

**!/ Risk of error:** Reading the wrong Appendix I table.



# HISTORIC TECHNICAL PASSPORT GUIDELINES

## HOW TO FILL THE FORM – PAGE 1

<b>Make represented :</b>	<b>SHELBY AMERICAN INC.</b> *	<b>Model represented :</b>	<b>COBRA 289 DAYTONA COUPE</b> *
<b>Year of specification :</b>	1965 *	<b>FIA identity n° :</b>	
<b>Engine type :</b>	FORD V8 OHV *	<b>Engine capacity :</b>	4840 cm <sup>3</sup> * Corrected : cm <sup>3</sup>
<b>FIA homologation form number (if applicable) :</b>	115	<b>Number of relevant valid pages of homologation form :</b>	9

**Make represented:** This is the make "represented" by the person who applies for the car's HTP (the "applicant", who can be either the owner of the car, or the person duly authorised by the owner of the car to submit the application). In this article and all the following ones, the word "represented" means that this entry is that which is declared by the applicant; this claim is therefore the sole responsibility of the applicant (see also grey box on Page 1 of the HTP).

**Advice:** For homologated cars, enter the make written on the Homologation Form.

**Model represented:** Model as declared by the applicant. Always use the homologated make and model for homologated cars.

**Advice:** For homologated cars, enter the model written on the Homologation Form.

**Year of specification:** The year in the FIA Appendix K Period in which the model was current. This year defines the technical specifications to which the applicant's car is purported to comply.

**Advice:** The year of specification is very important. It is defined according to the parts mounted on the car. If your car, manufactured in 1966, is equipped with a component contained in an extension of the Homologation Form issued in 1969, then your car's year of specification is 1969. If you use several extensions to the Homologation Form, then the latest one will be the one setting the year of specification. The period filled in previously must correspond to the year of specification.

**FIA identity No.:** To be completed by the ASN, according to instructions from the FIA.

**Engine type:** Number of cylinders, configuration and distributor type (e.g. Straight 4 DOHC; V8 OHC; V6 OHV; etc.). If the engine manufacturer is different from the car manufacturer, or if the engine is of a particular type (Essex, Climax, DFV, BDG, etc.), that must be stated in this field.

**!/\ Risk of error:** Writing "turbo" or the manufacturer's engine code, etc.

**Engine capacity and corrected engine capacity:** The capacity filled in here must always be the real and actual capacity, not the original one. For naturally aspirated piston engines, there is no corrected cubic capacity. Corrected cubic capacity only apply to forced induction engines or rotary piston engines. Check the car's Homologation Form or the period Appendix J for the coefficient that applies to your car, if relevant as in some periods, there was no equivalent.

**FIA Homologation Form number (if applicable):** If the car has a Homologation Form. A verified copy of it must always be attached to the HTP and brought to competitions.

**Number of relevant valid pages of Homologation Form:** If the car has a Homologation Form, complete the number of pages of the basic Homologation Form plus the number of extension pages that it is possible to use regarding the specification year and the chosen discipline(s).

### Pages 1 and 2 - Presentation photographs – Photos must be sharp and represent:

- The complete car, ready to race with or without its numbers;
- From  $\frac{3}{4}$  front right (Page 1) and  $\frac{3}{4}$  rear left (Page 2), the car must be presented in order to provide a complete view;
- There must be adequate and uniform light, no shadows;
- The stationary car with nobody on board;
- A limited amount of stickers are authorised, in accordance with Article 2.1.9 to Appendix K as well as for cars replicating a period livery and justified by a reference picture on Page 2;
- Windscreen strip are not allowed unless part of a period livery;
- Cars competing in rallies must be fitted with bumpers to the period specification of the model unless the model was homologated in period without bumpers.





# HISTORIC TECHNICAL PASSPORT GUIDELINES

## HOW TO FILL THE FORM – PAGE 2

Manufacturers Reference No. for Application

26/H/1



F.I.A. Recognition No.

1 127/1/ET

### ROYAL AUTOMOBILE CLUB

PALL MALL, LONDON, S.W.1.

### Federation Internationale de l'Automobile.

Amendment to Form of Recognition

Manufacturer: LOTUS CARS LTD.

Model: ELAN

#### VARIANT TO STANDARD PRODUCTION

2 AS FROM CHASSIS NO. 26/3901 ALL CARS ARE FITTED WITH

1. NEW DASH PANEL FACIA AND INTERIOR TRIM.
2. NEW REAR LIGHT CLUSTER.
3. GIRLING TYPE 14 FRONT DISC BRAKE CALIPER.
4. KNOCK-ON PRESSED STEEL DISC WHEELS  
RIM WIDTH 117.475 m.m.
5. CONNECTING ROD PART NO. 26E714 (125E)
6. VALVE (INLET) - MATERIAL EN.52  
DIAMETER OF HEAD OF VALVE 1.50"  
PART NO. B2442 (3)

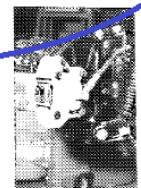
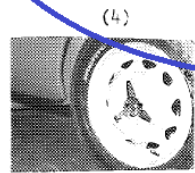
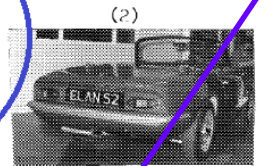
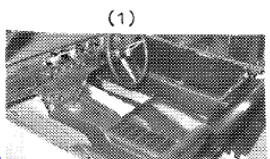

*Secured from  
Mr. J. M. G. G. G.  
J. G. G.*

Stamp of F.I.A./R.A.C. to be affixed here.

Date amendment is valid from

3 1/2/1965. to 14/1

Form: R.F.I.B.

#### List of extensions to the Homologation Form used:

List the different extensions to the Homologation Form in accordance with the parts featured on the car.

- 1 - Form extensions are marked with a number (1).
- 2 - Each extension lists the parts homologated by the manufacturer in period (2).
- 3 - Each extension has a date of homologation (3).

The latest extension determines the year of specification (requested on Page 1).

Advice: When listing the different extensions used on your car, count the number of extension pages permitted regarding your specification year and the disciplines required.

The number of pages of the base Form plus the number of extension pages permitted make up the number requested on Page 1 in the section "Number of relevant valid pages of Homologation Form".



**Mandatory:**



Period image. Event: NÜRBURGRING 1000KM

Date of the Event: 23/05/1965

IMPORTANT: If this model has no International History, tick this box:

**PERIOD IMAGE OF THE ORIGINAL CAR BODYWORK:** The reference picture has to be of a model that shares the period specification claimed for the presented car. Any difference between the presented car and the reference picture have to be corrected so that the reference car and the presented car are identical. In the case where the car has a livery, the reference picture is necessary.

**Event:** Name of the Competition and/or, as a minimum, of the location. The caption must be accurate enough so that the car can be identified in the classification of the relevant Competition.

**Date of the Competition:** Month and year formatted to DD.MM.YYYY.

**Box to tick regarding its history:** Under certain conditions, cars bearing a national history only may be issued with an HTP. In such cases, the ASN must avoid any ambiguity and indicate this clearly in the application. The box at the bottom of Page 2 must be ticked.

**! Full Competition name and Date (DD/MM/YYYY) are MANDATORY**

ISSUING ASN : ACCUS

FORM No USA-XXX1

### 1 – CHASSIS, SUSPENSION

#### 1.1 CHASSIS FRAME

[a]	Is the car fitted with a chassis to the period specifications?	YES	*
[b]	Not applicable		
[c]	Construction (girder, tubular, monocoque, etc.):	GIRDER	*
[d]	Materials:	STEEL	*

#### 1.2 FRONT SUSPENSION

[a]	Is the suspension as per the period specifications and dimensions?	YES	*
[b]	Not applicable		
[c]	Type of suspension (rigid axle, wishbones, de Dion, etc.):	TOP LEAF SPRING WITH BOTTOM WISHBONE	*
[d]	Type of spring (coil, leaf, torsion bar, etc.):	LEAF	*
[e]	Type of dampers (friction, lever, telescopic, etc.):	TELESCOPIC	*
[f]	Are the dampers adjustable?	YES	*
[g]	Please state the number of adjusters per damper (not the possible number of adjustment)	ONE	*
[h]	Material of the dampers:	STEEL	*
[i1]	Is the geometry of suspension adjustable?	YES	*
[i2]	Is the height of suspension adjustable?	YES	*
[i]	Please specify the method (Uniball joints, different mountings, etc.):		
	i1:	UNIBALL JOINTS	*
	i2:	SPACERS ON THE LEAF SPRING	*
[k]	Is it fitted with an anti-roll bar?	YES	*
[l]	Please specify, is this bar adjustable?	NO	*
[m]	Are sensors fitted?	NO	*
[n]	Not applicable		

1.1.[a]: Unless particular modifications are to be clarified, tick “YES”.

1.1.[b]: To be completed only if you have answered “NO” to question 1.1.[a].

1.1.[d]: Specify the main material(s) of which the chassis is constructed.

1.2.[f]: Specify if it is possible to adjust bump and/or rebound of the dampers. If yes, complete 1.2.[g].

1.2.[g]: State the number of adjusters per damper **! the number of adjusters is not the number or range of adjustment settings or clicks but the number of adjustment controls.**

1.2.[h]: Indicate the material of - **the main body** - the dampers.

1.2.[i]: Specify if the geometry or the height of suspension is adjustable by ticking “YES” or “NO”.

1.2.[j]: Specify the adjustment method for each of the above. Point [i1] is for the adjustment of the geometry and Point [i2] is for the ride height. The adjustments available depend on the parts mounted on the car. Two cars of the same model may not have the same setup possibilities if they are from a different group or period (even within the same period).

Section 1.3.: Same as Section 1.2.

ISSUING ASN : ACCUS

FORM No USA-xxx1

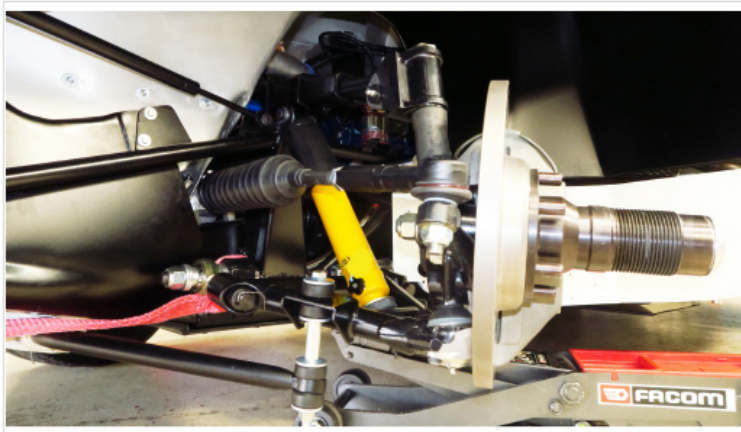

What must be visible:

- Upper and lower damper mountings;
- Ends of each pull rod;
- Wishbone(s) or axle(s);
- Mounted silent blocks and/or rose joints;
- Pivot between the stabilizer and the arm.



This photo clearly shows both sides of the wishbones and the two damper mountings and the anti roll bar is visible.

As these photos show most of the required points and are clear and well exposed, they are acceptable.

**⚠** If the car is fitted with drum brakes then for the side view photo the drum must be removed and included in the photo so that the inside of the drum is visible.

**⚠** The suspension has to be free on the photo (do not put the jack or axle stand under the wishbone but under the chassis).

ISSUING ASN : ACCUS

FORM No USA-XXX1

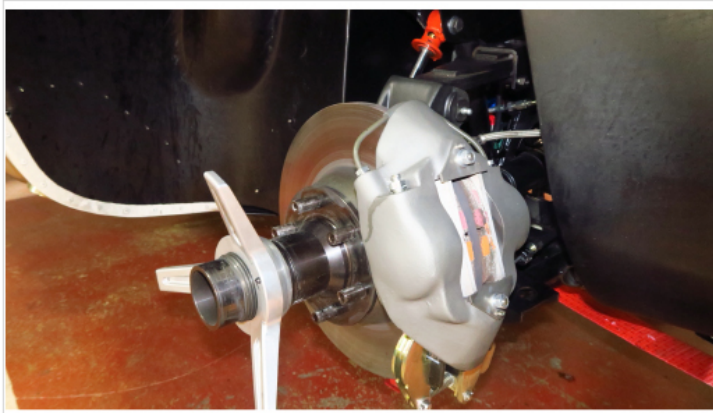

What must be visible:

- Upper and lower damper mountings;
- Ends of each pull rod;
- Wishbone(s) or axle(s);
- Mounted silentblocks and/or rose joints;
- Pivot between the stabilizer and the arm;
- If applicable, the handbrake linkage.



These photos show most of the elements requested. It is clear and well exposed. They are acceptable.

**⚠** If the car is fitted with drum brakes then for the side view photo the drum must be removed and included in the photo so that the inside of the drum is visible.

**⚠** The suspension has to be free on the photo (do not put the jack or axle stand on the wishbone but on the chassis).





# HISTORIC TECHNICAL PASSPORT GUIDELINES

## HOW TO FILL THE FORM – PAGE 7

ISSUING ASN : ACCUS

FORM No USA-XXX1

### 2 - ENGINE

#### 2.1 ENGINE

[a]	Is the engine as per the period specifications for this chassis?	YES	*
[b]	<i>Not applicable</i>		
[c]	Is the position of the engine as per the period specifications?	YES	*
[d]	<i>Not applicable</i>		
[e]	Is the cylinder block cast using the period specification material and dimensions?	YES	*
	Specify materials : CAST IRON		
[f]	<i>Not applicable</i>		
[g]	Is the cylinder head cast using the period specification material and dimensions?	YES	*
	Specify materials : CAST IRON      Casting number: C5FE		
[h]	<i>Not applicable</i>		
[i]	Make: FORD	Casting number of the block: C5AE-A	
[j]	Year of manufacture: 1985	Operating method: FOUR STROKE CYCLE	
[k]	Number of cylinders: 8	Configuration (straight, V, etc.): VEE	
[l]	Bore: original 101.80 mm	Stroke: original 72.90 mm	*
	actual 102.80 mm	actual 72.90 mm	*
[m]	Engine capacity: original 4727 cm <sup>3</sup>	actual 4840 cm <sup>3</sup>	*
[n]	Number of intake ports: 8	Number of plugs per cylinder: 1	*
	Number of exhaust ports: 8	Number of valves per cylinder: 2	*
	<i>Not applicable</i>		
	<i>Not applicable</i>		
[o]	Valve sizes to period specifications?	YES	*
[p]	<i>Not applicable</i>		
[q]	Are sensors fitted?	NO	*
[r]	<i>Not applicable</i>		

2.1.[e]: **!/ Risk of error:** Forgetting to specify the material.

2.1.[g]: **!/ Risk of error:** Forgetting to specify the material or the casting number.

2.1.[i] & [j]: Specify the make and year of manufacture of the engine.

**!/ Risk of error:** If the year of manufacture of the engine is different to the year of specification of the car, it has to be the exact same engine that was used in period on the model.

2.1.[n]: Number of ducts = Total number of intake or exhaust ports in the cylinder head(s).

**!/ Risk of error:** Regarding the spark plugs, the question refers to the number of spark plugs per cylinder and not to the total number of spark plugs.

ISSUING ASN : ACCUS

FORM No USA-XXX1

### 2.2 IGNITION

[a]	Is the system as per the period specifications?	YES	*
[b]	Not applicable		
[c]	Type (magneto, breaker/coil, etc.):	DISTRIBUTOR/BREAKER/COIL	*
[d]	If the ignition is electronic, specify the make and principle:		
[e]	Are sensors fitted?	NO	*
[f]	Not applicable		

### 2.3 FUEL FEED

[a]	Are the make, type and number of carburetors / injection as per the period specifications?			YES
[b]	Not applicable			
[c]	Carburetor: Number	4	Make	WEBER
	Type	48 IDA	ø of venturi	N/A mm
[d]	Injection :	Make	Type	
[e]	If an air restrictor is fitted, diameter of the restrictor: mm			
[f]	If supercharged, is the supercharger as per the period specifications?			
[g]	Not applicable			
[h]	Supercharger:	Make	Type	Number
[i]	If an air cooler is fitted, is it as per the period specifications?			
[j]	Not applicable			
[k]	Are sensors fitted?			NO
[l]	Not applicable			

2.2.[c]: The answer on the type of ignition must read:

- Typical "breaker" ignition – Distributor/Breaker/Coil
- Later "electronic" type – Distributor/Electronic/Coil
- If no distributor (Period J2) – Multi Coil/Crank Trigger/ECU

2.2.[d]: Specify the make and especially the principle of the ignition trigger.

Examples:

BMW M3 = Bosch DME Magnetic trigger

Porsche 911 SC = Bosch BHKZ Capacitive discharge

2.3.[c]: - For Group 1, 3 and N, it is mandatory to specify the homologated venturi diameter.

- For other groups, when the venturi diameter is left free by the period Appendix J, enter "N/A".

- If the diameter constantly varies, enter "variable".

! \ Risk of error: Confusing the external diameter of the body with that of the venturi. For Group 1 & 3 cars, you still have to specify the venturi diameter.

2.3.[d]: For a homologated car, refer to the car's Homologation Form.

Examples:

BMW M3 = Bosch DME

Porsche 911 SC = Bosch KJetronic

2.3.[e]: The restrictor diameter requested is the one required by the regulations applicable to the car. Refer to Appendix K and the period regulations, to find the accurate diameter.

2.3.[h]: Examples: Make: Garrett Type: T3

Make: Volkswagen Type: G40

ISSUING ASN : ACCUS

FORM No USA-XXX1

### 2.4 FUEL SYSTEM

[a]	Is the fuel system as per the period specifications?	YES	*
[b]	<i>Not applicable</i>		
[c]	Type of fuel feed (gravity, mechanical pump, electric pump, etc.):	WET SUMP	*
[d]	Is a fuel cooler fitted	NO	*
[e]	Is the fuel tank as per the period specification's location?	YES	*
	Does it comply with Appendix K?	YES	*
[f]	140 LITRES - FIA FT3-1999		
[g]	Are sensors fitted?	NO	*
[h]	<i>Not applicable</i>		

### 2.5 LUBRICATION

[a]	Is the system as per the period specifications?	YES	*
[b]	<i>Not applicable</i>		
[c]	Type (wet sump, dry sump, etc.):	WET SUMP	*
[d]	Is an oil cooler fitted?	YES	*
[e]	Is the cooler as per the period specifications?	YES	*
[f]	<i>Not applicable</i>		
[g]	Is a main circuit oil filter fitted (pre-war cars only)?		*
[h]	Are sensors fitted?	NO	*
[i]	<i>Not applicable</i>		

**2.4.[e]: MANDATORY** to clarify the capacity of the tank and the type used in accordance with Article 5.5 to Appendix K.

ISSUING ASN : Accus

FORM No USA-XXX1

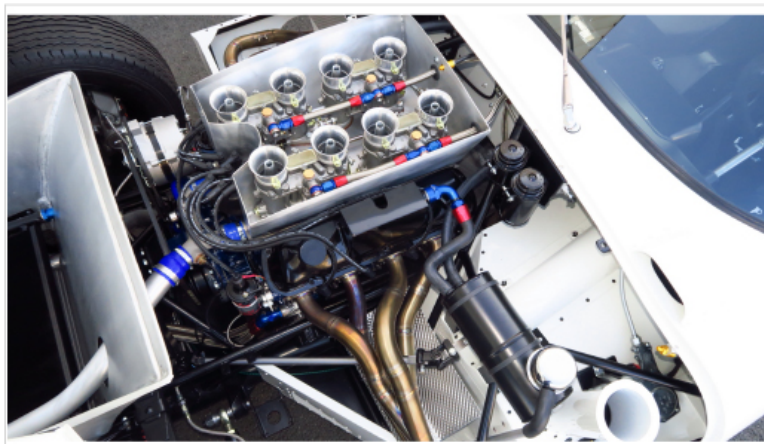
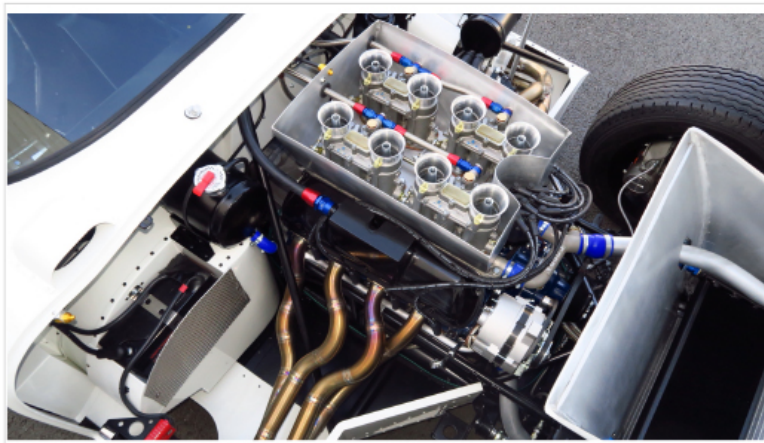

### Photos of the engine:

The photos of the engine must show the complete engine bay, the more we see, the better it is. Considering period specification or homologation requirements, top suspension struts are of interest, exhaust manifold as well. Obviously the more is included the better it will be to consider the Application, the opposite may lead to further queries.





ISSUING ASN : ACCUS

FORM No USA-XXX1

### 4 – BRAKES AND STEERING

#### 4.1 BRAKES

[a]	Is the braking system as per the period specifications?	YES	*
[b]	<i>Not applicable</i>		
[c]	Actuation (cable, rod, hydraulic, etc.): Front HYDRAULIC *Rear HYDRAULIC *Other option		*
[d]	Is the braking system assisted?	NO	*
[e]	<i>Not applicable</i>		
[f]	Make: Front GIRLING Rear GIRLING		*
[g]	If drum brakes: Drum diameter Front mm Rear mm Other mm		
	Shoe width Front mm Rear mm Other mm		
[h]	If disc brakes: Disc diameter Front 291.00 mm Rear 273.00 mm		
	Max. disc thickness Front 16.00 mm Rear 16.00 mm		
	Ventilated disc: Front No Rear No		
Callipers:	Material at front ALUMINIUM ALLOY Number of pistons per front calliper: 2		
	Material at rear ALUMINIUM ALLOY Number of pistons per rear calliper: 2		
[i]	Are sensors fitted?	NO	*
[j]	<i>Not applicable</i>		

#### 4.2 STEERING

[a]	Is the steering as per the period specifications?	YES	*
[b]	<i>Not applicable</i>		
[c]	Type (rack and pinion, worm and roller, etc.): RACK AND PINION		*
[d]	Is the steering assisted?	NO	*
[e]	<i>Not applicable</i>		
[f]	Are sensors fitted?	NO	*
[g]	<i>Not applicable</i>		

**4.1.[e]: Advice:** Enter here the type of assisted braking system, if applicable.

Example: vacuum, hydraulic, etc.



ISSUING ASN : ACCUS

FORM No USA-XXX1

### 5 - WHEELS

#### 5.1 WHEELS

[a]	Are the wheels as per the period specifications?	YES	*
[b]	Not applicable		
[c]	Are the wheels in multiple parts?	NO	*
[d]	Are the diameter and the width of the wheels as per the period specification?	YES	*
[e]	Not applicable		
[f]	Type and material (wire, pressed steel, alu alloy, magnesium alloy, etc.): Front: MAGNESIUM ALLOY      Rear: MAGNESIUM ALLOY		*
[g]	Diameters / widths of rims at the front (specify the units: inches or millimetres): *		
	1. Diameter: 15.00 * Width: 6.00 *	2. Diameter: 15.00      Width: 7.50	
	3. Diameter: 15.00      Width: 8.50	4. Diameter:      Width:	
[h]	Diameters / widths of rims at the rear (specify the units: inches or millimetres): *		
	1. Diameter: 15.00 * Width: 6.00 *	2. Diameter: 15.00      Width: 7.50	
	3. Diameter: 15.00      Width: 8.50	4. Diameter:      Width:	
[i]	Are sensors fitted?	NO	*
[j]	Not applicable		

#### 6.1 BODY

[a]	Is the body to the original specification?	YES	*
[b]	Not applicable		
[c]	Not applicable		
[d]	Is all the material of the body as per the period specifications?	YES	*
[e]	Main material: ALUMINIUM If other material used specify material and body parts:		*
[f]	Type (single-seater, coupé, etc.): COUPE		*
[g]	Number of seats: 2		*
[h]	Number of doors: 2		*

#### 6.2 AERODYNAMIC DEVICES (cars built after 1965 only)

Not applicable

**5.1.[g] and [h]: Advice:** Only enter each wheel size once for each axle. For homologated cars from Period G1 onwards, if there are more than four sizes of wheel on either axle you can enter a range (ex: from 6" to 8" or 6-8).

**! Risk of error in this example:**

[g] 1. Diameter: 13 Width: 6 2. Diameter: 13 Width: 6  
3. Diameter: 13 Width: 7 4. Diameter: 13 Width: 7

**6.1.[e]: ! Risk of error:** Forgetting to complete the second part of the question. Some cars have body panels in a material that differs from the main body, typically bumpers, side skirts, doors or hard tops.

**6.1.[f]:** If available, refer to the Homologation Form of the car. For non-homologated cars, it is generally "Single-Seater-Racing-Car" or "Two-Seater-Racing-Car".

**6.1.[g] and [h]: Advice:** Enter the number of doors and seats originally fitted.

**! Risk of error:** Entering the number of doors and seats as per the car's current configuration.

**6.2.[a]:** For all cars built after 1965, fill in this section as well as:

- Page 20 for homologated cars.
- Page 22 for non-homologated cars.
- Page 21 for cars equipped with wings.

ISSUING ASN : ACCUS

FORM No USA-XXX1

### 6.3 LIGHTING

[a]	Is the lighting as per the period specifications?	YES
[b]	Not applicable	
[c]	Is generator fitted?	YES
[d]	Type: dynamo <input type="checkbox"/> alternator <input checked="" type="checkbox"/> other, specify and justify	

### 7.1 DIMENSIONS

[a]	Wheelbase: left 2280.00 mm right 2280.00 mm
[b]	Only for homologated cars from Period G2 onwards, body width at centre line of axles: Original front mm Current front mm Original rear mm Current rear mm
[c]	For all other cases, track (track measured between the centres of the tyre treads): Original front 1416.00 mm Current front 1416.00 mm Original rear 1416.00 mm Current rear 1416.00 mm
[d]	Minimum weight: 865 kg
[e]	Clarification:

### 8 – DRAWINGS AND/OR PICTURES

If necessary, drawings and/or pictures of the aerodynamic devices, suspension, etc



### 9 – ADDITIONAL PIECES OF INFORMATION

If necessary, list of alternatives (gearbox ratios, etc)

**7.1.[b]:** To be completed only for homologated cars, except for Group 1, 3 and N, from Period G2 onwards. The measurement is to be done from one side of the bodywork to the other, at the vertical going through the center of the wheel hubs.

**!/\ Risk of error:** Confuse case [b] with [c].

**7.1.[c]:** To be completed for all other cars (i.e. non homologated , pre Period G2 and all periods Gr. 1, 3 or N cars). The measurement is to be done from the ground level between the centres of the tyre treads.

**!/\ Risk of error:** For all homologated cars of Group 1, 3 or N, the track must be detailed, not the body width, even from Period G2.

**7.1.[d]:** For homologated models, the weight is stated on the Homologation Form or in Appendix J. For cars from Period J1 onwards, the weight of the rollcage as specified at the end of period Appendix J must be added. For non-homologated cars, refer to the end of period Appendix J.

### Section 8 – Drawings and/or Pictures

If the car is fitted with adjustable dampers as per Page 3 Section 1.2.f and/or Page 5 Section 1.3.f, pictures of the adjusters (knobs, screws, reservoirs, etc.) are mandatory under that section.



### Presentation photographs

As for the presentation photographs on Page 1, front, back and side views of the car must represent:

- The complete car, ready to race with or without its numbers;
- There must be adequate and uniform light, no shadows;
- The stationary car with nobody on board;
- **A limited amount of stickers are authorized including race numbers**, in accordance with Article 2.1.9 to Appendix K as well as for cars replicating a period livery and justified by a reference picture on Page 2;
- Windscreen strip are not allowed unless part of a period livery;
- Cars competing in rallies must be fitted with bumpers to the period specification of the model unless the model was homologated in period without bumpers.





### Photo of the dashboard:

The photo of the dashboard must show all the instruments used.

For homologated cars, the dashboard must conform to the homologation.  
For non-homologated cars, the dashboard must conform to the period specification.

The speedometer and/or original instruments may be replaced by an alternative to the original one providing it is of an analogue type and it remains in the original housing.

Digital instruments which cannot be proven to be part of the period specification and/or additional used for timekeeping or any sort of data logging are forbidden.



### Photo of the boot:

Mandatory for cars with a boot, for other type of cars, please see the next slide.

### Alternative photos

Mandatory for cars without a boot, especially single and two seat racing cars, show the non engine end with all bodywork removed.

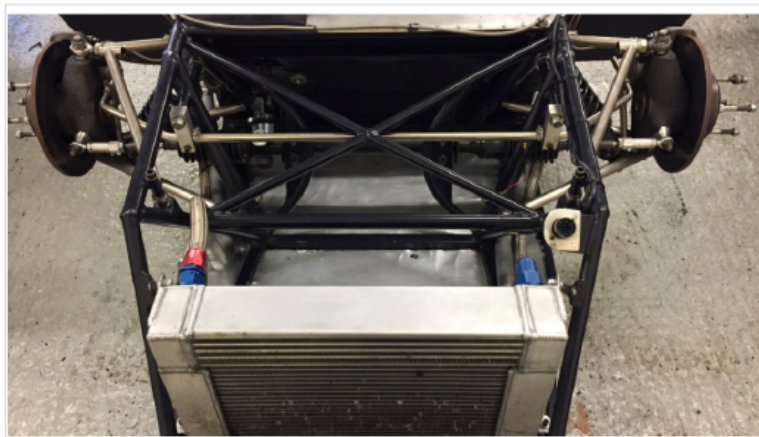



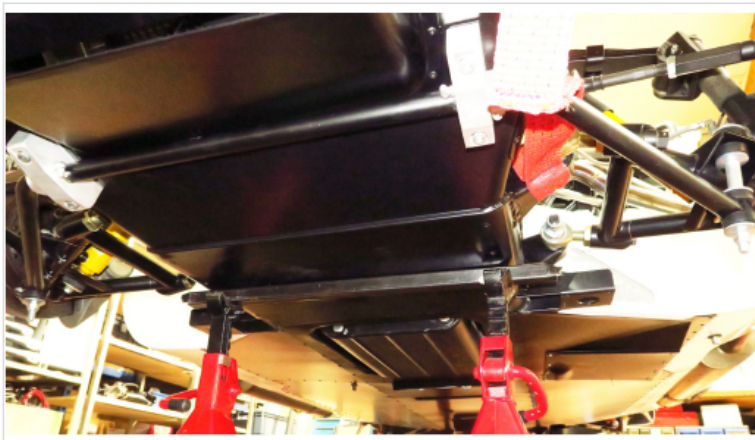

### Photo of the underfloor:

The photo must show the full floor, it can be taken with a simple jack and axle stands.

### Additional note for the underfloor photo:

Mandatory for Porsche cars, this enables us to identify the exhaust manifold but it's also valuable to see where the 4 into 1 of particular exhaust come in or to view the tunnels of the diffuser. Always think about the added benefit of the picture.



ISSUING ASN : ACCUS

FORM No USA-XXX1

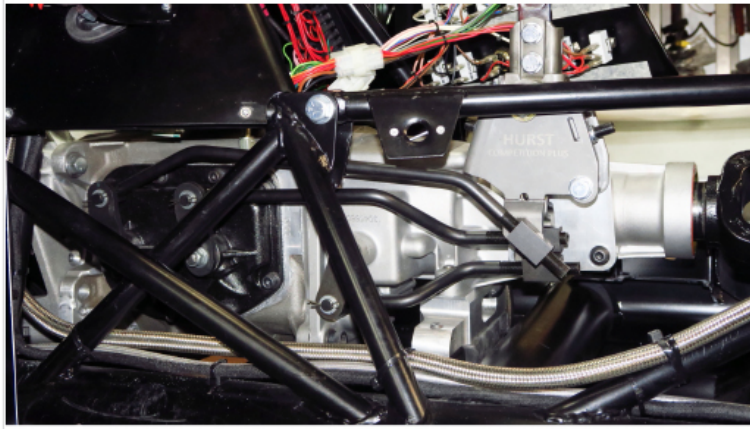

### Photo of the gearbox:

The photo must show the gearbox clearly and in colour to make it possible to identify the casing.

Note that as much as possible the gear linkage must be visible.

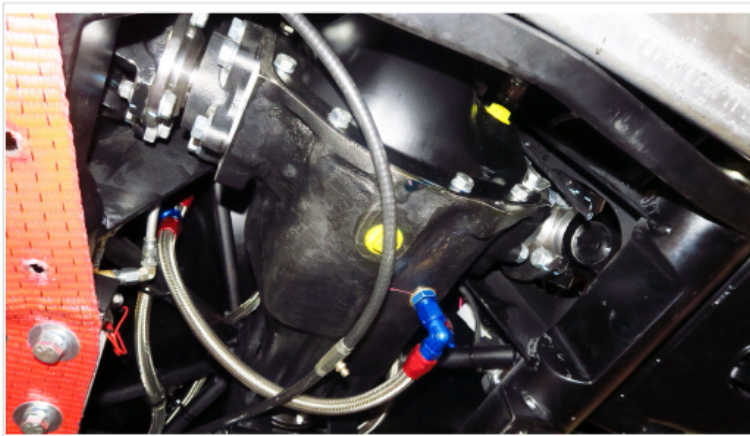

### Photo of the axle:

The photo of the axle must show the final drive casing clearly.

As shown here, also visible is the oil cooler.

**⚠ We do not accept having twice the same photo.**

ISSUING ASN : ACCUS      FORM No USA-XXX1

**EXTENSION – AERODYNAMIC DEVICES (MEASUREMENTS)**

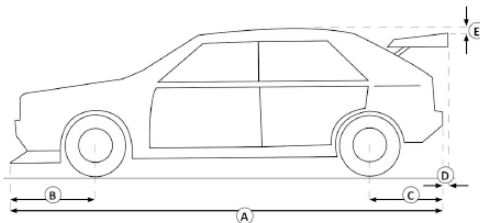

DIMENSIONS (TOLERANCE FOR ALL DIMENSIONS: +/-1%)

[A]	mm
[B]	mm
[C]	mm
[D]	mm
[E]	mm

**Article 12:** A, B and C to be completed for all cars from 1966 onwards; D and E when the car is equipped with an aerodynamic device (wing, spoiler, splitter, etc.).

ISSUING ASN : ACCUS

FORM No USA-xxx1

**DIMENSIONS**  
(TOLERANCE FOR ALL DIMENSIONS: +/-1%)

[A]	mm
[B]	mm
[C]	mm
[D]	mm
[E]	50 mm min.
[F]	mm
[G]	mm
[H]	mm
[I]	mm
[J]	mm
[K]	mm
[L]	mm
[M]	mm

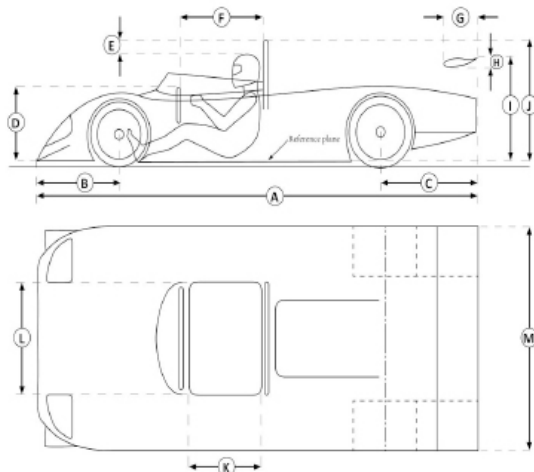

**DIMENSIONS**  
(TOLERANCE FOR ALL DIMENSIONS: +/-1%)

[A]	mm
[B]	mm
[C]	mm
[D]	mm max.
[E]	50 mm min.
[F]	mm
[G]	mm
[H]	mm
[I]	mm
[J]	mm

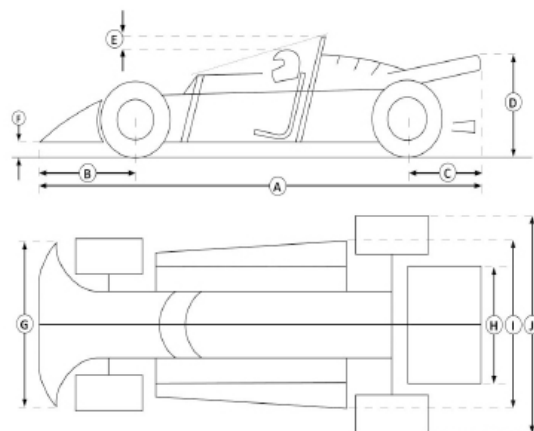

For a Single-Seater Racing Car or Two-Seaters-Racing-Car built after 1965, these section are mandatory.



1.1 ROLL OVER PROTECTION SYSTEM	
[a] System in accordance with:	SELECTION *
SELECTION	
1.2 FIA HOMOLOGATED SYSTEM	FIA HOMOLOGATION FORM
<i>Not applicable</i>	ASN CERTIFICATE
	CURRENT APPENDIX K
	PERIOD SPECIFICATION (App J) [NON HOMOL. CARS ONLY]
	NOT APPLICABLE -> PERIOD A-E ONLY

1.5 PERIOD SPECIFICATION SYSTEM					
[a]	Main/Lateral bar	Front bar	Diagonals	Other struts	Cross braces *
Outer diameter (mm)					
Wall thickness (mm)					
[b]	Material specification:				
[c]	Drawing numbers according to App. K - App. VI (including the basic drawings and drawings of all options used):				
[d]	Number of mounting points to bodyshell / chassis:				
<i>*WHEN NO DIMENSION IS APPLICABLE, PLEASE FILL N/A FOR THOSE SPECIFIC FIELDS</i>					
1.6 FURTHER INFORMATION, IF NECESSARY:					

**Page 23 is one of the major changes of the 2020 HTP Template.** The main one being that only the section applicable to the car presented will be visible.

This means that depending on the type of ROPS fitted, Section 1.2 will only show up if you've chosen FIA Homologation Form. And if no ROPS is fitted to the car, with the example of a Pre-War or Period E car, none of the section will be applicable and the specific field will have to be used.

**Second change**, all fields linked to dimensions must be filled in. If not applicable, it is mandatory to fill "N/A".

All permitted aluminium, titanium and/or integral ROPS must be entered as Period Specification System under Section 1.5

*For any additional information and regulatory text, please refer to Appendix V and VI to Appendix K for ROPS.*





ISSUING ASN : ACCUS

FORM No USA-XXX1

### EXTENSION – ROLL OVER PROTECTION SYSTEM – PART 1

#### 1.1 ROLL OVER PROTECTION SYSTEM

[a] System in accordance with: CURRENT APPENDIX K \*

#### 1.2 FIA HOMOLOGATED SYSTEM

*Not applicable*

#### 1.3 ASN CERTIFIED SYSTEM

*Not applicable*

#### 1.4 APPENDIX K SYSTEM (SELF MADE)

[a]	Main/Lateral bar	Front bar	Diagonals	Other struts	Cross braces
Outer diameter (mm)	40	N/A	40	40	N/A
Wall thickness (mm)	2	N/A	2	2	N/A
[b]	Material specification: COLD DRAWN SEAMLESS UNALLOYED CARBON STEEL				
[c]	Drawing numbers according to App. K - App. VI (including the basic drawings and drawings of all options used): K-1   K-12				

*\*WHEN NO DIMENSION IS APPLICABLE, PLEASE FILL N/A FOR THOSE SPECIFIC FIELDS*

#### 1.5 PERIOD SPECIFICATION SYSTEM

*Not applicable*

#### 1.6 FURTHER INFORMATION, IF NECESSARY:

A Roll Over Protection Structure (ROPS) may either be:

- **Fabricated** in compliance with the requirements of Appendix VI to Appendix K
  - This is a « Current Appendix K » ROPS under 1.1.(a)
  - Materials and dimensions must be detailed under 1.4
  
- **Homologated or Certified by an ASN** in accordance with the requirements of Appendix V or VI as well as the current Homologation Regulations for Historic ROPS
  - This is an « ASN Certificate » ROPS under 1.1.(a)
  - Article 1.3.(a) must be completed and the relevant certificate must be signed and transmitted through by the ASN with the Application.
  
- **Homologated in period** by the FIA which is defined as being part of the original Homologation Form as an extension (VO).
  - This is an « Homologation Form » ROPS under 1.1.(a)
  - Article 1.2.(a) must be completed and the relevant extension must be attached and transmitted through by the ASN with the Application.
  
- **Period Specification**, which is defined as one that was used in competition, in period, on the actual make and model of car.
  - This is a « Period Specification » ROPS under 1.1.(a)
  - Materials and dimensions must be detailed under 1.5
  - This is only applicable to non-homologated cars as well as specific GT, GTS and GTP cars of Period F for Circuit/Hill Climb ONLY.

*For any additional information and regulatory text, please refer to Appendix V and VI to Appendix K for ROPS.*



### Additional information and guidance regarding ROPS:

- The 50mm rule
  - For all open cars of Period F onwards the top of the ROPS must be a minimum of 50mm above the top of the driver's helmet.
- Extensions
  - Any ROPS extension fitted will render the structure as non-compliant unless certification can be produced.
- Period specification and Integral and/or Titanium ROPS
  - An integral and/or titanium ROPS may only be considered if period specification;
  - Additionally and for the integral one, it is defined as one that is part of the structure and that cannot be separated without partial or total destruction of the car from one of its components. Rivet removal and/or monocoque disassembly is however not considered as destruction;
  - If any integral and/or titanium ROPS is a feature of the car, it is mandatory to mention it under Page 23/1.5.(b).
- Except for the addition of a horizontal bar to fix the harnesses, a diagonal member (orientation optional), or to fit door bars, any modification to a homologated, certified or period specification ROPS is forbidden.
  - Other than the above, any additional elements, welding or machining will be considered a modification.
- « Elements used in period » is defined as design, not tube material specification and dimensions or joining methods.

*[For any additional information and regulatory text, please refer to Appendix V and VI to Appendix K for ROPS.](#)*

### TECHNICAL REGULATIONS

- The car must comply with the technical regulations for Group: [REDACTED]  
of Appendix: [REDACTED] VIII & IX TO APPENDIX K 2019
- Or, the car must comply with the following technical regulations: APPENDIX J (from 19 65 ).  
**The regulations of current Appendix K have priority.**

**Article 14:** The various scenarios are:

- The car corresponds to regulations for a defined group in a period Appendix J, for which the year needs to be specified.
- The car corresponds to an Appendix (VIII, IX, X or XI) to the current Appendix K.
  - *C/CT & GT/GTS of Period E, F & G1 → Appendices VIII & IX.*
  - *Formula One from 1966 → Appendix X.*
  - *Rally and Hill Climb cars of Period J1 & J2 → Appendix XI.*
- The car is not homologated → Article 6 of Appendix K.

**⚠ In case of a non-homologated ROPS, do not forget to complete and sign Page 27.**



*PURPOSE OF THE DOCUMENT*

*THE APPLICATION PROCEDURE*

*GENERAL FEATURES*

*HOW TO FILL THE FORM*

*PICTURES & FORMAT*

*ROPS CERTIFICATES*

*COMMON MISTAKES*

## PRESENTATION PHOTOGRAPHS

Photographs must be of sufficient quality to enable a scrutineer to verify the specification of the car.

Please take photos from a distance to provide a wide enough frame, especially given the new 16:9 format - (1280x720px).

The car can be displayed with race stickers and a minimum amount of decals, on the ground and ready to race with steering column in neutral position.

Clear and uncluttered background is highly recommended, the photos have to be clear enough and as best as possible, must avoid any shadow.



Photos must always be in “landscape” format.



## SUSPENSION PHOTOGRAPHS

The purpose of these photos is to show the precise specification of the drivetrain of the car. The photos must be clear and accordingly framed.

Pay attention to the light on the photos. Photos that are too dark or blurred will be refused.

Show the whole suspension, especially the brake callipers and discs and the majority of mounting points between the chassis and the wheel hubs. If possible, showing the calliper opening for the brake pads and its attachment system in place.

The suspension must be free. Put the jack or axle stand under the chassis, not the wishbone.

If the car is fitted with drum brakes, the drum must be removed and its inner face must appear on the photograph.

Photos must always be in "landscape" format.

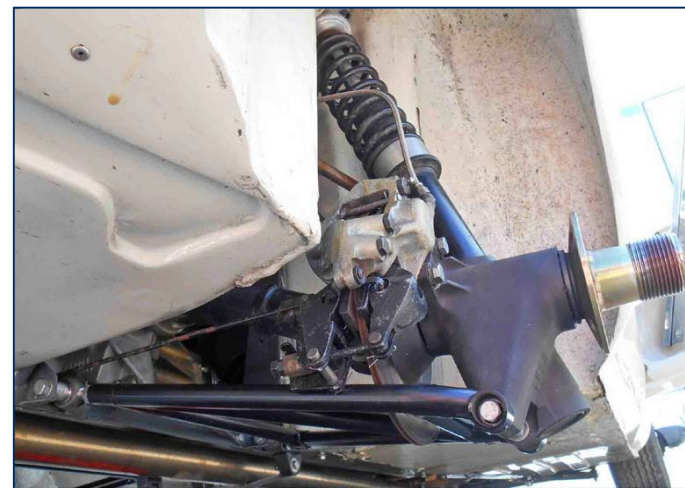
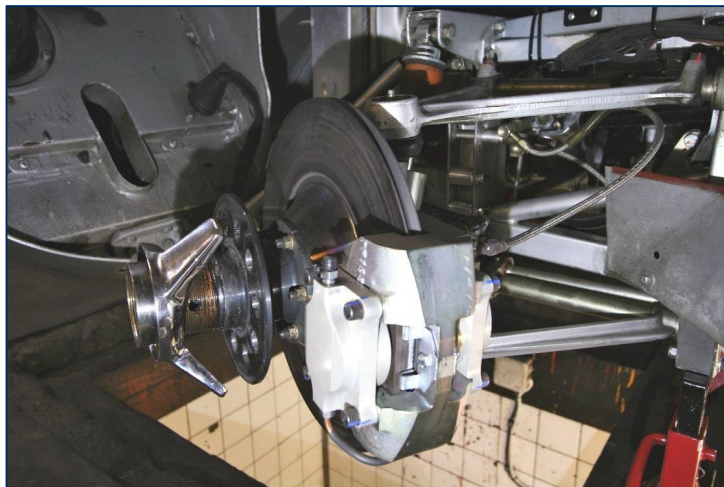

Photos were taken with the car on the floor using only a jack and axle stands.

## ENGINE PHOTOGRAPHS

These photos have to be taken from each side of the car.  
Not in front of it.

Please note that the whole engine bay must be displayed, not simply a close-up of the engine.

The content must display the car in ready-to-drive condition with all ancillary parts (battery, bonnet,...).

For cars having a large air filter housing (for example, American V8 cars), take one photo with (so that we can check its conformity to period specification) and the other without (so we can see more details, like the carburettor(s) for example).





# HISTORIC TECHNICAL PASSPORT GUIDELINES HOW TO TAKE YOUR PHOTOS – ENGINE

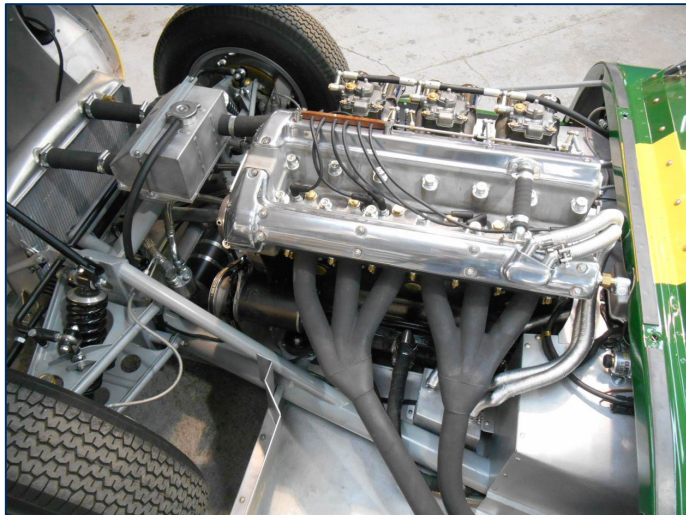



## PORSCHE 911 ENGINE PHOTOS

Particularity of the Porsche 911's engine photos, it must to show the upper mount of the dampers.

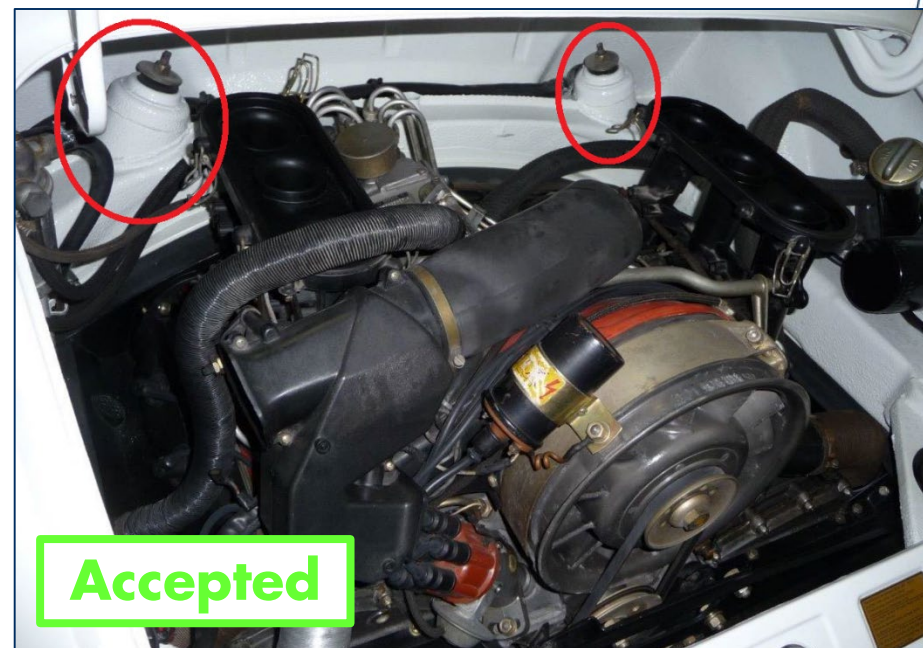
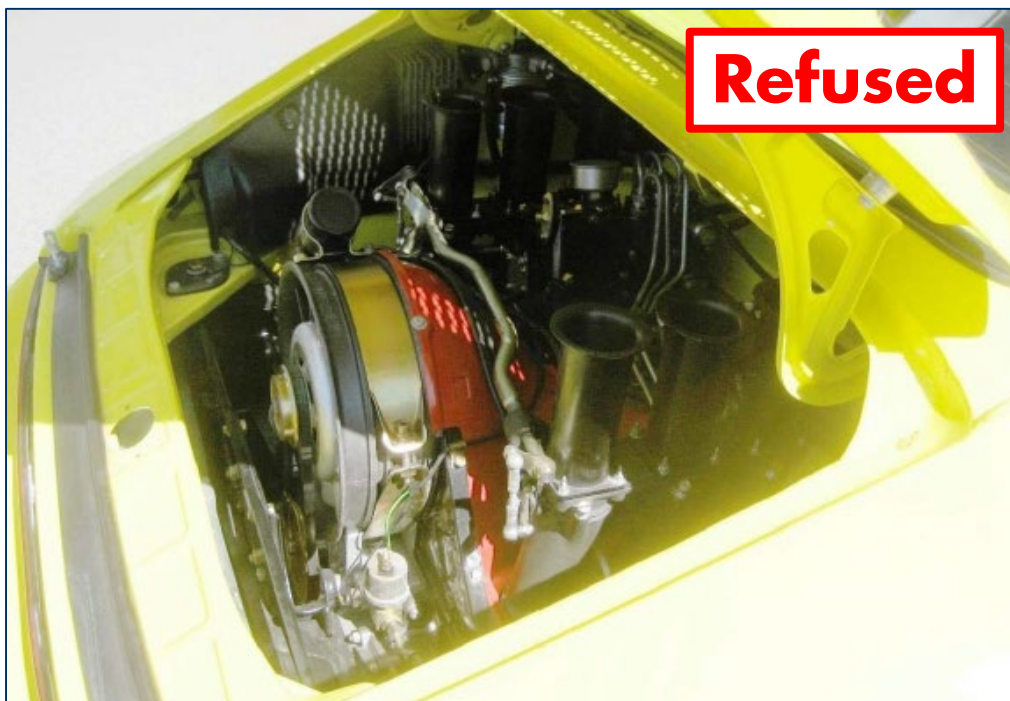

## GEARBOX AND AXLES PHOTOS

Gearbox photos must display selection and/or clutch mechanism, if visible in the near perimeter.

Example: A Period F Ford Cortina Lotus has a master-cylinder on the near left side of the bell-housing → the photo has to show it.

All photos must be landscape view, not portrait view.

All GT and Touring Cars are homologated and road legal. Therefore they must be equipped with their handbrakes and cables. If a hydraulic handbrake is fitted to the car, this must correspond to the Homologation Form or period specification.

For Two-Seater-Racing-Cars with transaxles, a good option is to simply take one photo from each side of the car.

For Single-Seater-Racing-Cars, a photo from one side and second from the rear may add clarity.



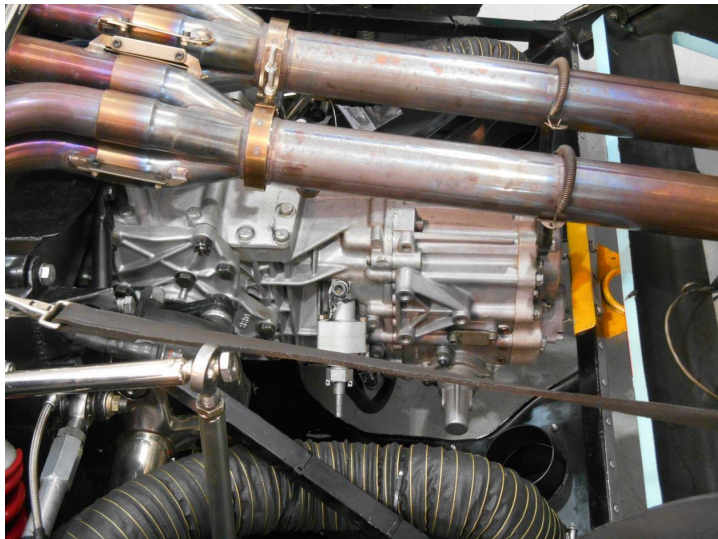
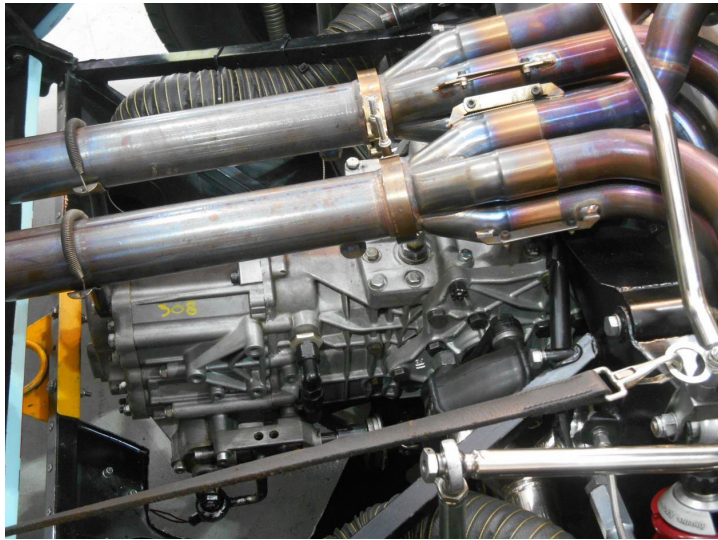

Two-Seater-Racing-Car

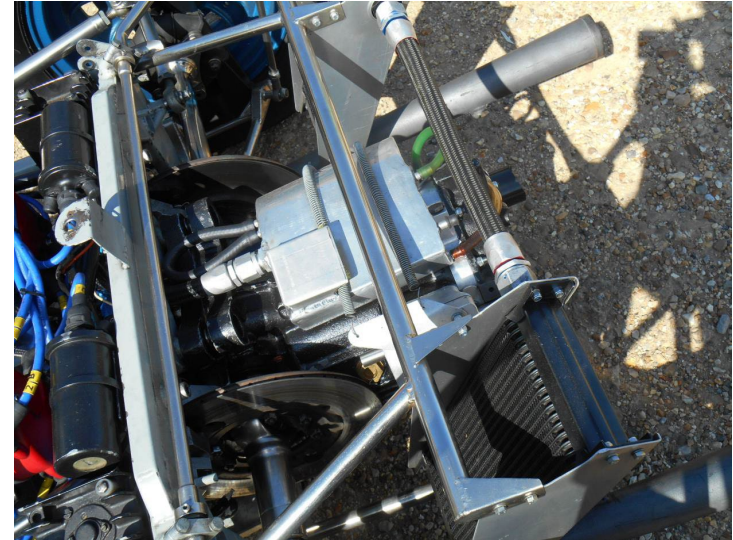

Single-Seater-Racing-Car



*PURPOSE OF THE DOCUMENT*

*THE APPLICATION PROCEDURE*

*GENERAL FEATURES*

*HOW TO FILL THE FORM*

*PICTURES & FORMAT*

*ROPS CERTIFICATES*

*COMMON MISTAKES*





# HISTORIC TECHNICAL PASSPORT GUIDELINES ROPS CERTIFICATES



## Roll Over Protection System Description

This document is specific to the Safety Cage bearing the serial number on page 4.  
The Roll Cage Design, Materials and all Mountings are to FIA specification

Make:	PORSCHE	Year or Model ID:	
Model:	911	Vehicle Homologation Number:	
Roll Cage Design Number:	P 911 /02>>	ROPSD No:	120813

Drawing of front ¾ view of the complete structure (with ID plate shown)

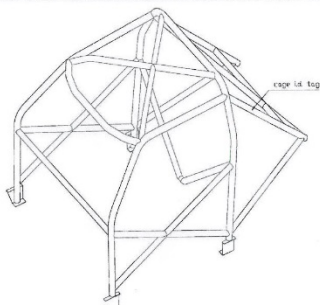

This Roll Over Protection System has been designed to meet current FIA Appendix J regulations, in particular Appendix J, articles 253.8.2 and 253.8.3.  
It complies with drawing numbers: 253-3, 253-4, 253-9, 253-12, 253-17, 253-28, 253-29 and 253-31.

1 Bald Close, Daventry  
Northants, NN11 8RY  
Tel: 01327 872855  
Fax: 01327 300758  
E-mail: info@customcages.co.uk

Custom Cages Letter of Conformity

Page 1 of 1

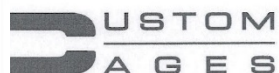

Photo 2

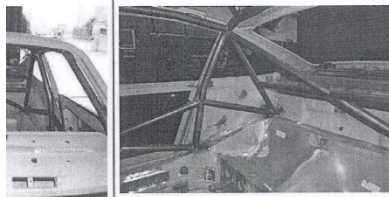

Photo 4

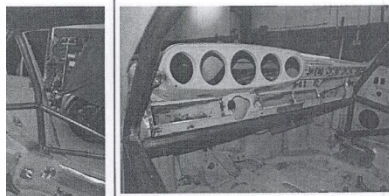
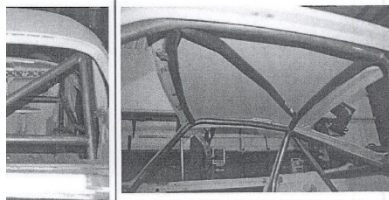

Photo 6



1 Bald Close, Daventry  
Northants, NN11 8RY  
Tel: 01327 872855  
Fax: 01327 300758  
E-mail: info@customcages.co.uk

Page 2 of 2



Photo 7



Photo 8



1 Bald Close, Daventry  
Northants, NN11 8RY  
Tel: 01327 872855  
Fax: 01327 300758  
E-mail: info@customcages.co.uk

Page 3 of 2



All Dimensions ±0.1mm	Show location of each type on drawing				
	Label	Grade of Steel	External Diameter	Wall Thickness	Min. Tensile Strength
Main Rollbar	T45	45mm	2.5mm	700 N/mm <sup>2</sup>	
Lateral Rollbar	T45	40mm	2mm	700 N/mm <sup>2</sup>	
Back Stays	T45	40mm	2mm	700 N/mm <sup>2</sup>	
Diagonal Bar	T45	40mm	2mm	700 N/mm <sup>2</sup>	

The following agent is authorised to act on the manufacturer's behalf to install this safety cage design

Agent's Name	Steve Lancaster
Address	Old School House Long Drax Selby Yorks YO8 9NH
Phone No. & Email	0773 4103958

**Refused**

### Manufacturer's Declaration & Details

- I declare that the Safety Cage Structure described on this certificate conforms to the following details:
- Was constructed and installed in accordance with the specifications and design shown herein.
  - Has been manufactured so that all aspects of the Safety Cage design, including fabrication and strength requirements and joints and demountable joints and mountings, will be in conformity with the requirements of the FIA Homologation Regulations for Safety Cages.
  - Has been identified by an engraved plate bearing the name or logo of the manufacturer and a unique manufacturer's serial number

Signature		
Name of Signatory	Roger Nevitt	

1 Bald Close, Daventry  
Northants, NN11 8RY  
Tel: 01327 872855  
Fax: 01327 300758  
E-mail: info@customcages.co.uk

Custom Cages Letter of Conformity

Page 4 of 4

This certificate sports the manufacturer's signature.  
But it doesn't sport the signature of the ASN or the FIA. It is not acceptable.



# HISTORIC TECHNICAL PASSPORT GUIDELINES ROPS CERTIFICATES



DMSB CERTIFICATE NUMBER

2-623/67-S



DMSB CERTIFICATE NUMBER

2-623/67-S



DMSB CERTIFICATE NUMBER

2-623/67-S

## SAFETY CAGE CE

In compliance with FIA Homologation Re

This Certificate is valid only for the Safety Cage bearing I

Name of Safety Cage Manufacturer:	Wiechers GmbH
Address:	Südring 4 31582 Nienburg / Weser Germany
Phone no.:	+49 (0)5021 601360
Fax no.:	+49 (0)5021 12

1) The structure shown on this form is manufactured for th		
Make	Porsche	Model/Type 911
Vehicle Homologation Number(s) If applicable:	3025	

2) Drawing of front v

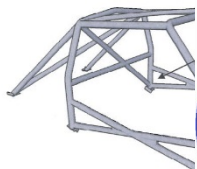

It is accepted by all parties and entities concerned w  
in the last resort, the FIA and DMSB hold full authorit  
this certificate in case of difficulties regarding the ap  
and/or requirements referred to above.

Copyright©2008 by FIA - All rights reserved

### 3) DETAILS OF STRUCTURE

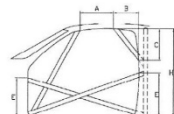

A =            mm      B =            mm  
C =            mm      E = 270    mm  
H = 815    mm      (highest figure only)

Show location of each type on drawing

± 0.1mm	Main Rollbar	Front/Lateral Rollbar	Backstays	Main rollbar Diagonal members
External Diameter	45 mm	45 mm	41,3 mm	40 mm
Wall Thickness	1,5 mm	1,5 mm	1,5 mm	1,5 mm
Method of attachment to Body Shell	welded in			
Weight of Safety Cage, inc. fastenings	27,0 kg			

5) This document is valid only if fully completed and issued as a validated original document by the DMSB. It must be presented, in full, on demand to FIA or ASN delegates or Technical Scrutineers of the Meeting (Event). The authorisation of this form by the issuing ASN certifies that the structure shown herein complies with the basic strength and configuration requirements of the FIA Homologation Regulations for Safety Cages. It does not certify that the structure complies with the requirements or any provisions of any national or technical regulations. This certificate becomes invalid if the structure is modified in any way from the design shown herein.

6) FOR THE USE OF THE DMSB ONLY  
The issuing ASN (DMSB), having been satisfied that the Safety Cage design identified in this Certificate has been demonstrated to meet the requirements of the FIA Homologation Regulations for Safety Cages, certifies that the design of the Safety Cage Structure is valid for use, subject to the restrictions listed below, in all events sanctioned by the issuing ASN and International events sanctioned by the FIA.

Name of Authorising Officer:	Dieter Fürst
Position:	Head Technical Department
Signed:	<i>Dieter Fürst</i>
Date:	07.09.2009

6.1) Remarks/Restrictions (For the use of the DMSB only)

a) Generally the certificate is valid for all type of events:     yes     no

b) Certificate is only valid for type of events without co-driver:     yes     no

c) Certificate is valid for DMSB-groups:     yes     no

d) Certificate is valid for FIA-groups:     yes     no

e) Certificate is valid for group:    only appendix K

The certificate is not valid in groups in which a FIA-homologation is necessary, e.g. Super 2000.

Copyright©2008 by FIA - All rights reserved

Page 2 of 7

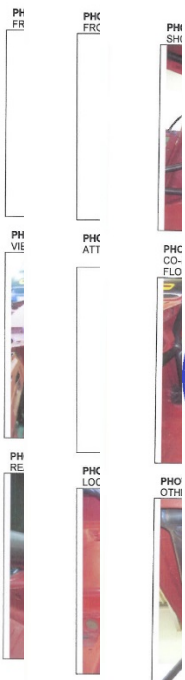

Copy

Copy

Copy

7)

Safety cage/rollbar serial number:	
V.I.N. / Chassis Identification Number of the car:	
Copy of certificate handed out to the customer on (date):	

8) MANUFACTURER'S DECLARATION AND DETAILS:  
I declare that the Safety Cage Structure described on this form and fitted to the vehicle described above  
a) was constructed and installed in accordance with the specifications and design shown herein.  
b) has been manufactured so that all aspects of the Safety Cage design, including configurati  
strength requirements and welded and demountable joints and mountings, will be in conformity w  
requirements of the FIA Homologation Regulations for Safety Cages.  
c) has been identified by an ungraved plate bearing the name or logo of the manufacturer, the  
Certificate number, a unique and individual manufacturer's serial number.

Manufacturer's Name:	Wiechers GmbH
Address:	Südring 4 31582 Nienburg / Weser Germany
Phone n° + Email:	+49 (0)5021 601360 service@wiechers-sport.de
Signature:	<i>I.A. J. Werfelmann</i>
Name of Signatory:	Jennifer Werfelmann
Date:	07.09.2009

9) FURTHER REMARKS:

Copyright©2008 by FIA - All rights reserved



Page 6 of 7

### E SAFETY CAGE STRUCTURE SHOWING

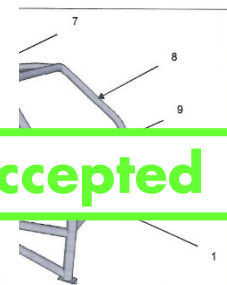

Accepted

each type on drawing

nr	Wall Thickness	Min. Tensile Strength
n	1,5 mm	695 N/mm <sup>2</sup>
n	1,5 mm	695 N/mm <sup>2</sup>
n	1,5 mm	695 N/mm <sup>2</sup>
n	1,5 mm	695 N/mm <sup>2</sup>
n	1,5 mm	695 N/mm <sup>2</sup>
n	1,5 mm	695 N/mm <sup>2</sup>
n	1,5 mm	695 N/mm <sup>2</sup>
n	1,5 mm	695 N/mm <sup>2</sup>
n	1,5 mm	695 N/mm <sup>2</sup>
n	1,5 mm	695 N/mm <sup>2</sup>

Page 7 of 7

This certificate sports the manufacturer's signature.

It does sport the logos, stamps and signature from an ASN which recognizes the compliance of this ROPS to the applicable FIA homologation regulations. It is acceptable.



*PURPOSE OF THE DOCUMENT*

*THE APPLICATION PROCEDURE*

*GENERAL FEATURES*

*HOW TO FILL THE FORM*

*PICTURES & FORMAT*

*ROPS CERTIFICATES*

*COMMON MISTAKES*



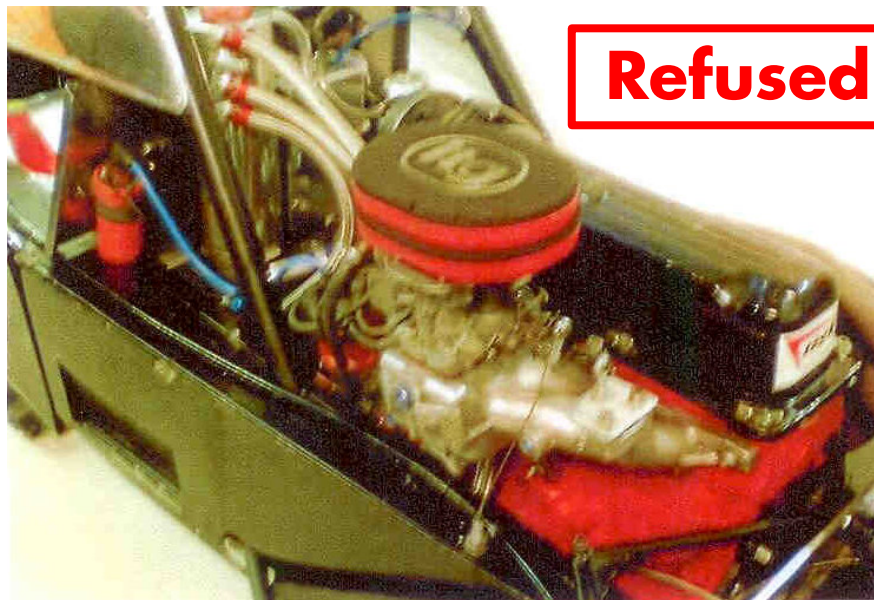

**Refused**

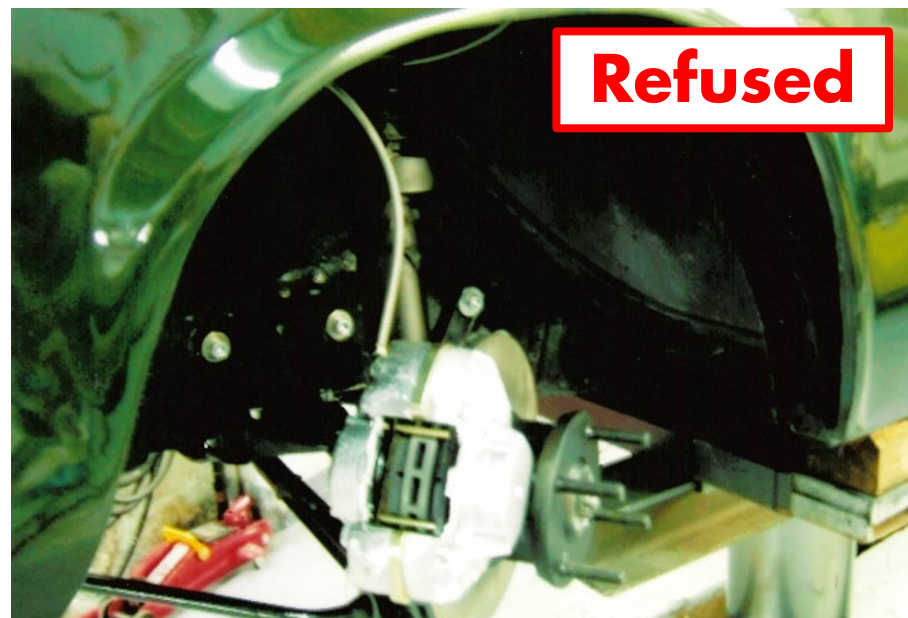

**Refused**



**Refused**

Insufficient quality of  
the photos.





The car has to be presented with limited amount of stickers or advertisement (except in case of period livery).



Wrong proportions.





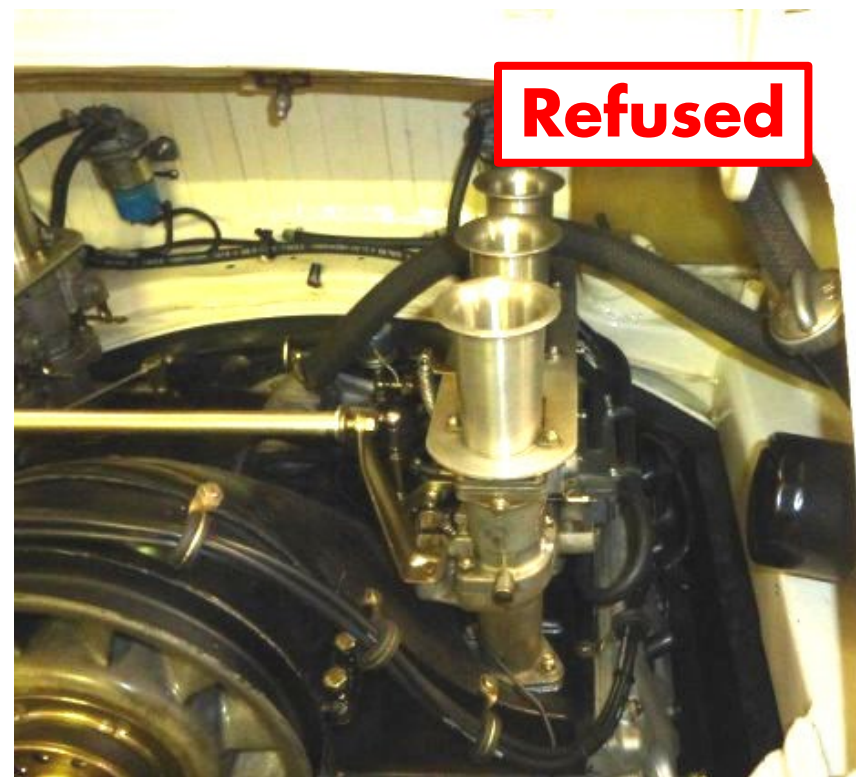
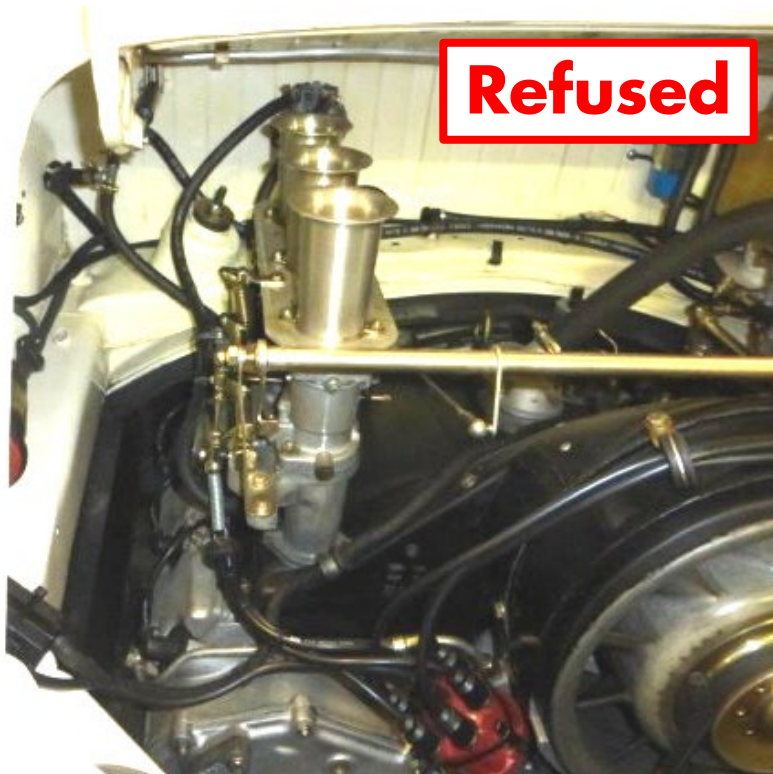

Photos have to show the whole engine bay.

**Refused**



The car must be on a ready-to-race condition on the photos. Nothing should be covered.